

AC INFINITY

CLOUDWAY

WHOLE HOUSE FAN SYSTEM

USER MANUAL

WELCOME

Thank you for choosing AC Infinity. We are committed to product quality and friendly customer service. If you have any questions or suggestions, please don't hesitate to [contact](#) us. Visit www.acinfinity.com and click contact for our contact information.

EMAIL

support@acinfinity.com

WEB

www.acinfinity.com

LOCATION

Los Angeles, CA

MANUAL CODE CW2209X1

PRODUCT

CLOUDWAY S10
CLOUDWAY S12
CLOUDWAY S14
CLOUDWAY S16
CLOUDWAY S18
CLOUDWAY T10
CLOUDWAY T12
CLOUDWAY T14
CLOUDWAY T16
CLOUDWAY T18

MODEL

AC-CRS10
AC-CRS12
AC-CRS14
AC-CRS16
AC-CRS18
AC-CRT10
AC-CRT12
AC-CRT14
AC-CRT16
AC-CRT18

UPC-A

819137023031
819137023048
819137023055
819137023062
819137023079
819137021082
819137021099
819137021136
819137021143
819137021150



SERIOUS INJURY OR DEATH. Please do not touch the fan's impeller and blades. Secure all nearby objects including wires and cables from coming into contact with the fan's impeller and blades. Use caution when deciding where to install this fan.

MANUAL INDEX

Manual Index	Page 5
Product Warning	Page 6
Key Features	Page 7
Product Contents	Page 8
Installation Guide	Page 9
Installation	Page 10
Powering and Setup	Page 18
Controller Mounting	Page 22
UIS™ Platform	Page 27
Compatibility	Page 28
Add More Fans	Page 30
Add More Devices	Page 31
Cleaning	Page 32
Programming	Page 33
Other Settings	Page 58
Download the App	Page 59
Add a Device	Page 60
FAQ	Page 67
Other AC Infinity Products	Page 70
Warranty	Page 71

PRODUCT WARNING



TO REDUCE THE RISK OF FIRE, ELECTRIC SHOCK, OR INJURY TO PERSONS, OBSERVE THE FOLLOWING:

1. Ensure your power source conforms to the electrical requirements of this product.
2. Check your local code restrictions for additional safety measures that may be needed for a proper code compliant installation.
3. Read all instructions before installing and using this product.
4. If you are unfamiliar or have doubts about performing this product's installation, seek the services of a qualified, trained, and licensed professional. Inappropriate installation will void this product's warranty.
5. Do not attempt to hardwire this product. Performing any retrofitting actions may result in personal injury and/or electrical damage, and will void this product's warranty.
6. This product must not be used in potentially hazardous locations such as flammable, explosive, chemical-laden or wet atmospheres.
7. Ducted products must always be vented to outdoor areas.
8. Do not cover power cords with rugs or other fabric materials.
9. This product has rotating parts. Safety precautions should be exercised during the installation, operation, and maintenance of this product.
10. Do not insert or allow fingers or foreign objects to enter any ventilation or exhaust openings as it may cause electric shock, fire, or damage to this product. Do not block or tamper with this product in any manner while it is in operation.
11. Do not depend on the on/off programming as the sole means of shutting power from this product. Unplug the power cord before installing, servicing, or moving this product.
12. Do not operate this product while its cord is damaged, or if it malfunctions, has been dropped, or is damaged in any manner.

KEY FEATURES

QUIET EC MOTOR

PWM-controlled motor features precise speed control, reduced rotor noise, and energy efficient EC Voltage.

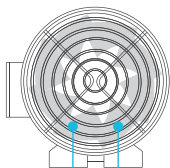
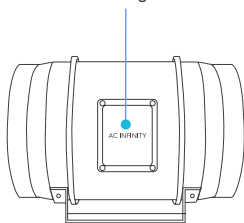

STATOR BLADE FANS

The system with high static pressure rating can deliver high airflow even when air movement is being restricted.

AUTOMATIC SHUTTERS

Automatic shutters that open and close in response to airflow, and close completely when airflow stops.

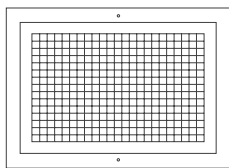
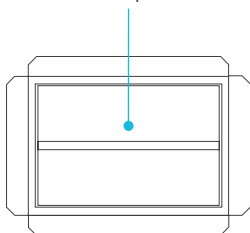

IP44 PROTECTION

The blower unit is sealed to Ingress Protection 44 standards to be highly resistant to liquid and dust.

SMART CONTROLS

Features ten speed control. Select models activate the fan with temp and humidity triggers, timers, and schedules.

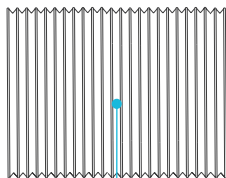
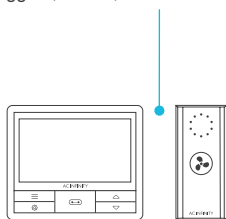

INSULATED DUCTING

The outer layer is made of dual PVC thermoplastic that protects the aluminum from cuts and tears.

PRODUCT CONTENTS

CLOUDWAY WHOLE HOUSE FAN SYSTEM (Included in all series)

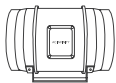

DUCT FAN SYSTEM
(x1)

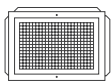

DAMPER BOX & GRILLE
(x1)



DUCT TUBE
(x1)



FAN GUARD
(x1)



ROPE CLIP
(x2)



DUCT CLAMP
(x2)

S-SERIES



WIRELESS CONTROLLER
(x1)



WIRELESS RECEIVER
(x1)



CONTROLLER PLATE
(x1)



AAA BATTERIES
(x2)

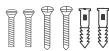

MACHINE PLATE SCREWS
(x2)



WOOD SCREWS
(WALL HANG)
(x2)

T-SERIES



SMART CONTROLLER
(x1)



SENSOR PROBE
(x1)



UIS M - 4PIN F
ADAPTER
(x2)



WOOD SCREWS
(WALL HANG)
(x2)

MOUNTING HARDWARE (Included in all series)



WIRE MOUNT
(x6)



PROBE MOUNT
(x1)



FAN SCREW
(x4)



DAMPER SCREW
(x8)



GRILLE SCREW
(x4)

INSTALLATION GUIDE

PROTECTIVE GEAR

Before you begin, make sure to protect yourself from potential injuries by wearing protective gear including: safety goggles to prevent any drywall dust or insulation from getting in your eyes, gloves to avoid direct contact with insulation, and a dust mask to avoid inhaling dust as a result of cutting into the drywall and insulation.

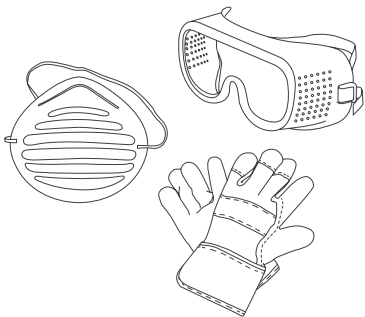

FAN POSITIONING

A whole house fan is installed in the ceiling of a home and moves air from the living space into the attic. It forces hot air out of the attic and pulls cooler air from the outside of the house into the living space, which is ideal for people who come home to a hot house when it is cooler outside.

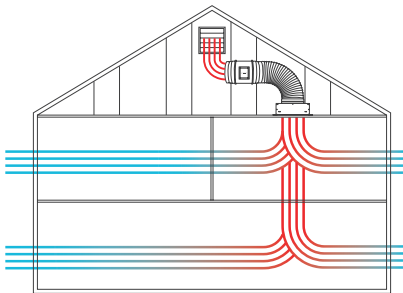

INSTALLATION

STEP 1

Before installing the whole house fan, find a location in the hallway or staircase central to the home.

In the attic, mark the corners using the grille plate in between the ceiling joists. Then press each corner with a screwdriver or drill until it reaches the other side.

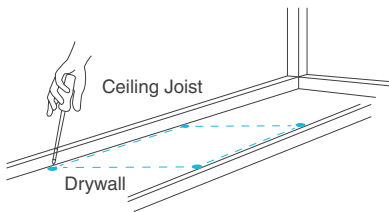

STEP 2

Line up the grille plate with the reference holes made in the attic. Mark around the grille plate to create a cutout guide.

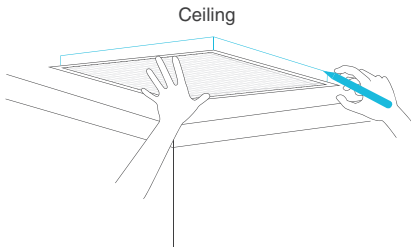

INSTALLATION

STEP 3

Check your location and measurements before cutting into the drywall. Use a drywall saw or jigsaw to cut out the marked location.

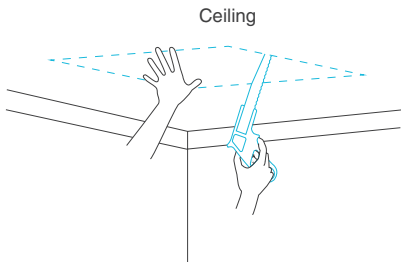

STEP 4

Remove the white grille plate off the damper box. Inside the attic, place the damper box vent side down onto the cut hole, as shown in the image.

The black damper screws may also be used to secure the damper box to the drywall. Drill through the metal to mount the damper box.

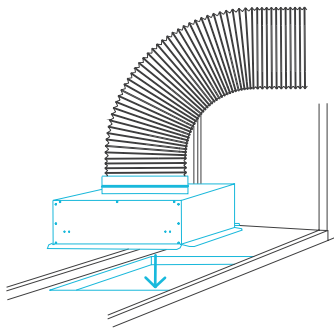

INSTALLATION

STEP 5

Loosely attach the duct tube to the fan to determine the mounting area. Position the fan in an area where it can be mounted. Remove the duct tube after positioning the fan.

As an option you may use the included rope clips to hang your fan from a support beam instead of mounting it.

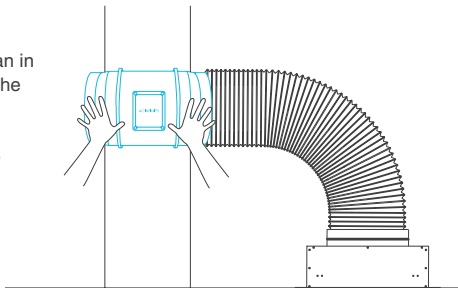

STEP 6

Once a location has been set for the fan, remove the metal rings so you can pull out the center motor.

Use the mounting flanges to help you position the fan to your desired mounting location.

Use a pen or pencil to mark the four mounting holes.

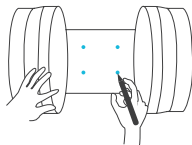

INSTALLATION

STEP 7

Double check to make sure the location is structurally sound and free from obstruction.

Use a power drill to drill the four mounting holes.

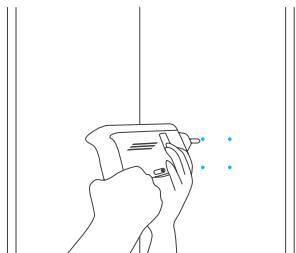

STEP 8

If you are mounting onto anything other than a wood support or stud, insert the included four wall anchors into the drilled mounting holes.

You may need to use a hammer to secure them through the holes.

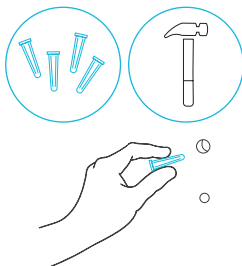

INSTALLATION

STEP 9

Position the mounting flanges and align the mounting holes with the wall anchors. Use a screw driver or drill to secure the four wood screws through the mounting frame and into the wall anchors or stud.

Make sure the arrow is pointing in your desired direction.

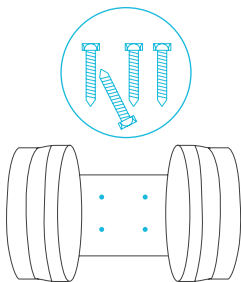

STEP 10

Place the metal rings back onto the flanges.

Position the wind circle back into the flange. Do not tighten the screws yet.

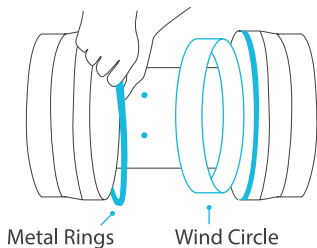

INSTALLATION

STEP 11

Secure the motor box back onto the mounting flanges.

Make sure the arrow on the motor box points in the same direction as the arrow on the exhaust flange.

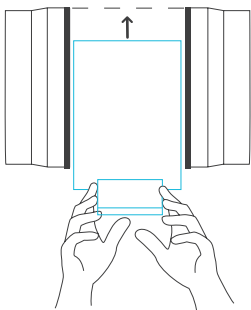

STEP 12

Connect the duct tube to the intake flange. Secure the duct clamp over the duct tube and tighten it with a flathead screw driver.

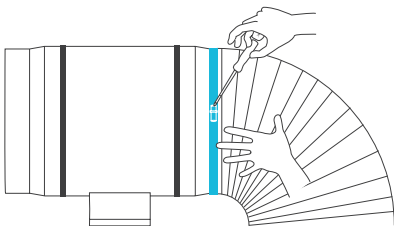

INSTALLATION

STEP 13

Use the included rope clips to support the duct tube. Clip them onto a nearby beam.

If there is no beam or an area to hang the rope clips, secure a nail nearby to hook the rope clips onto.

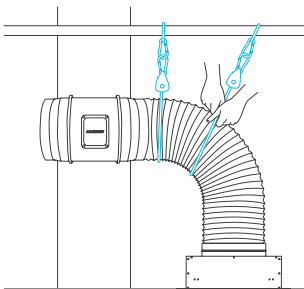

STEP 14

To tighten the rope, pull the loose end until the duct tube feels secured. Avoid sharply bending the tube so airflow won't be restricted.

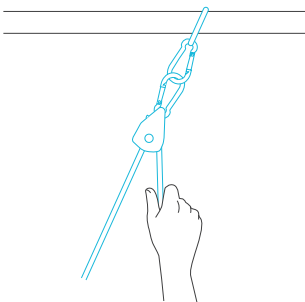

INSTALLATION

STEP 15

Below the ceiling, place the vent onto the damper through the opening.

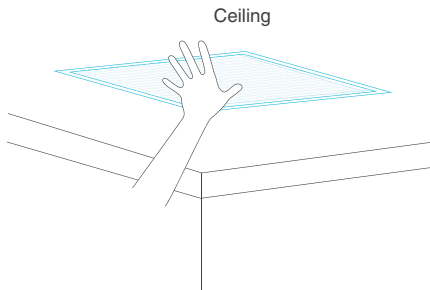

STEP 16

Secure the vent using the included four white screws into the drywall.

*Note: The screws will only secure the vent to the ceiling drywall. The damper will rest on the drywall and vent.

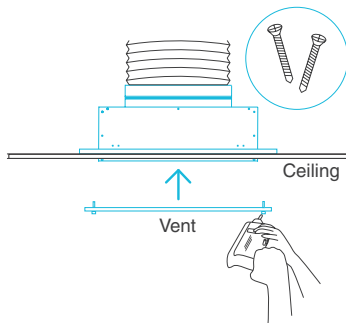

POWERING AND SETUP

S-SERIES

STEP 1

Plug the fan's connector into the wireless receiver.

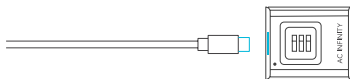

STEP 2

Insert the two AAA batteries into the wireless receiver controller.

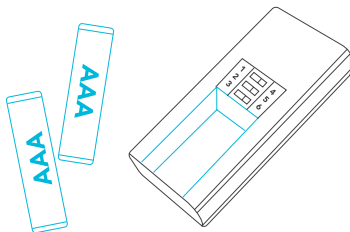

POWERING AND SETUP

S-SERIES

STEP 3

Adjust the sliders on the controller and receiver so that their numbers match. Close the controller's battery door when you are finished. The receiver's indicator light will flash when connected.

Any number of devices may be controlled using the same controller, as long as the fans' sliders match the controller's.

Any number of controllers may control the same device, as long as the controllers' sliders match the fan's.

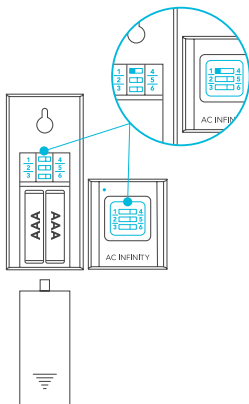

POWERING AND SETUP

T-SERIES

STEP 1

Plug your device's UIS connector into one of the controller's ports.

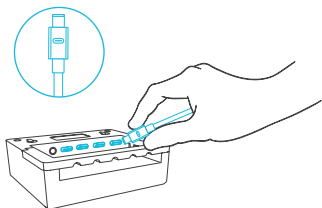

STEP 2

Plug the sensor probe into the controller's 3.5mm jack. Route the probe head to spot areas as needed.

Keep the probe cord away from your HID* grow light ballast's power cord to ensure the controller properly detects climate conditions.

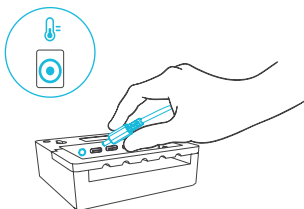

*MH, HPS, CMH, or CHPS

POWERING AND SETUP

T-SERIES

STEP 3

Plug the fan's power cord into a wall outlet.

The controller will receive power from the fan to operate. (EC Motor fans only)

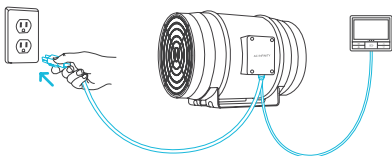

STEP 4

You may use the included tie mounts, wood screws, and wire ties to cable manage the cords.

Secure the tie mounts onto a surface using the wood screws. Loop the wire ties around the cords into the tie mounts.

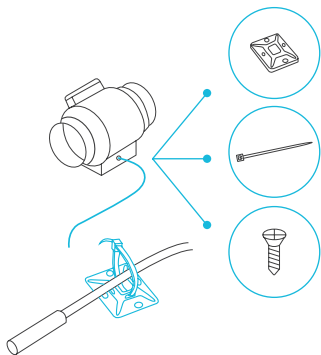

CONTROLLER MOUNTING

S-SERIES

STEP 1 — WALL MOUNTING

Locate a spot free of obstruction and secure the anchors into your wall.

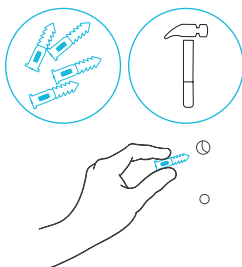

STEP 2 — WALL MOUNTING

Line the controller plate along with the anchors and apply the wall plate screws, making sure the magnet lies on the upper half.

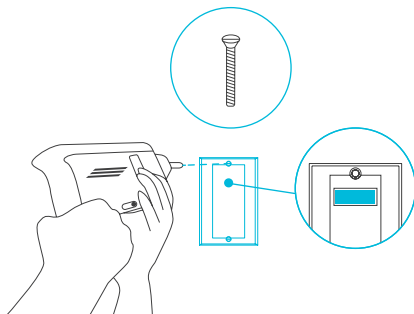

CONTROLLER MOUNTING

S-SERIES

STEP 3 — WALL MOUNTING

Magnetically mount the controller onto the controller plate.

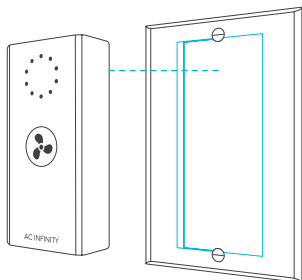

MAGNET MOUNTING

Mount the controller on a steel surface using the magnet located on its backside.

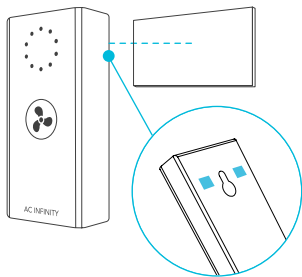

CONTROLLER MOUNTING

T-SERIES

POSITIONING

Position the controller close to the fan and inside the attic so that the power cord reaches the controller.

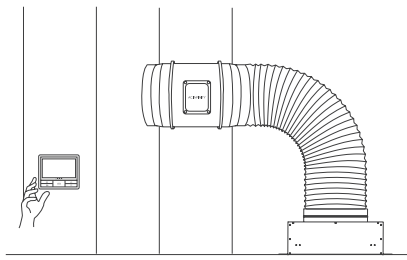

STEP 1 — WALL MOUNTING

Locate a spot free of obstruction and secure the anchors into your wall. Twist the wood screws into the anchors.

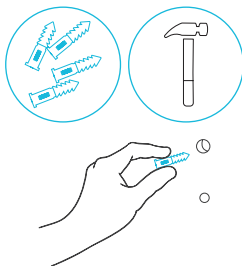

CONTROLLER MOUNTING

T-SERIES

STEP 2 — WALL MOUNTING

Hang the controller by the screws using the holes on the backside.

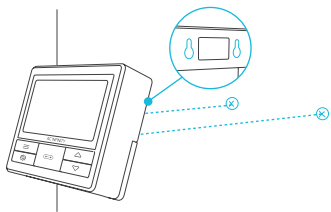

MAGNET MOUNTING

You may also mount the controller onto a steel surface using the magnet located behind the label.

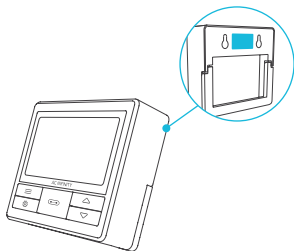

CONTROLLER MOUNTING

T-SERIES

CORD ARRANGEMENT

Cords may be routed into or outside of the kickstand grooves, and through a cut hole behind the controller.

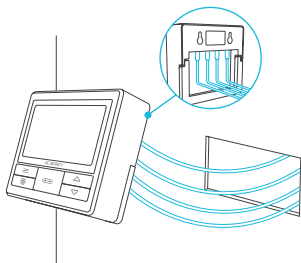

KICKSTANDING

Open the stand behind the controller to set it tilted on your desktop.

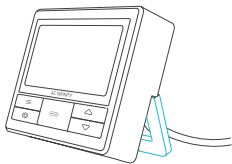

UIS™ PLATFORM

The UIS™ platform enables you to connect a single central controller with several ventilation devices simultaneously. By creating this fully integrated system, you can power and program all your devices together or separately for optimized room ventilation management.

Use select smart controllers to set triggers that will activate your devices based on your environment's temperature and humidity. Create independent timers and schedules for customized activation in your desired timeframe.

Your system can be regulated using your controller hub or remotely on the AC Infinity app (paired with compatible controllers), where you will have access to automation programming and climate data.

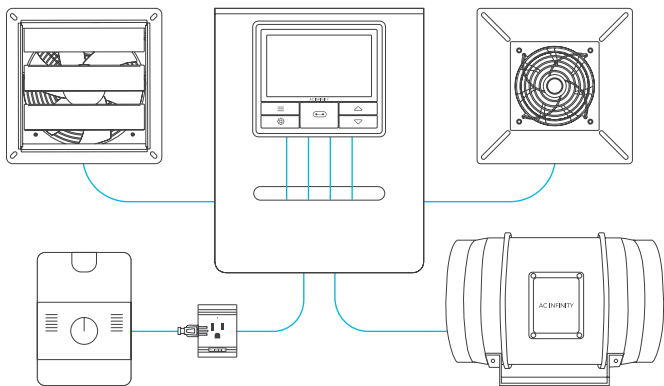

Central controllers, mounting plates, and ventilation devices will be sold separately and may still be in development at the time of your purchase of this product.

COMPATIBILITY

UIS™

MOLEX ADAPTER

Use the included Molex adapter to plug inline fans with 4-pin Molex connectors into this controller. Plug your fan's Molex connector into the adapter. Then plug the adapter into the controller.

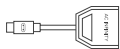

UIS M - 4PIN F
ADAPTER

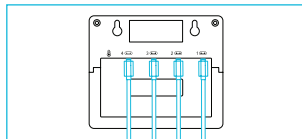

EXTENSION CABLE*

Use male-to-male UIS extension cords to connect devices with female UIS ports at an extended range from your controller.

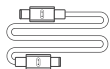

UIS M - M
CORD

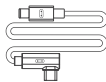

UIS M - M
CLIP FAN CORD

EXPANSION DONGLE*

The expansion dongle will allow you to connect 2 or 4 devices with a single port and can support additional dongles to create more expansion ports (up to 64 units supported with the use of 20 dongles). Intended for exclusive use with AC Infinity controllers built with UIS ports.

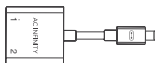

UIS M - M
2 PORT DONGLE

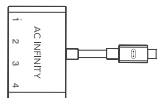

UIS M - M
4 PORT DONGLE

*Not included

COMPATIBILITY

CONTROLLER 69 PRO

The CONTROLLER 69 PRO is compatible with AC Infinity fan models that contain EC-motors. An EC-motor fan will have two cords coming out of its motor box for the power and the controller. Note that certain models that previously used DC-motors now contain EC-motors in updated builds.

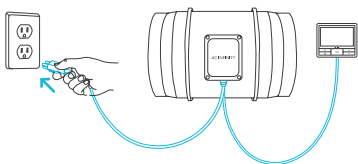

EC Motor - Compatible

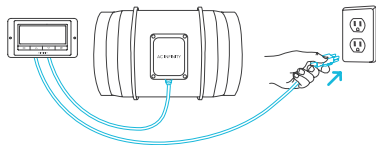

AC or DC - NOT Compatible

ADDING MORE FANS

The CONTROLLER 69 PRO is built with four ports that enable you to power and control multiple fans at the same time. Compatible with inline fans with EC motors only. See image below for a sample configuration.

Multi-Fan Connection

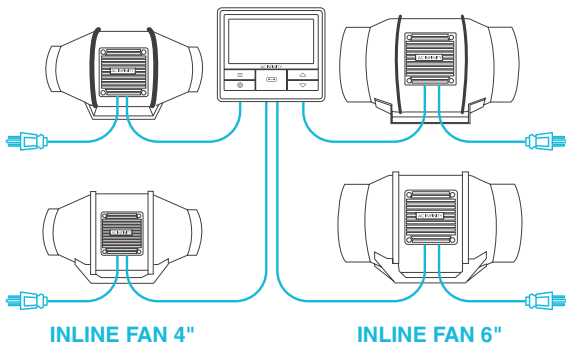

MOLEX ADAPTER

Use the included UIS to 4-pin Molex adapter to connect your fan to the Universal Controller (not included). Plug your fan's UIS connector into the adapter. Then plug the adapter into your controller.

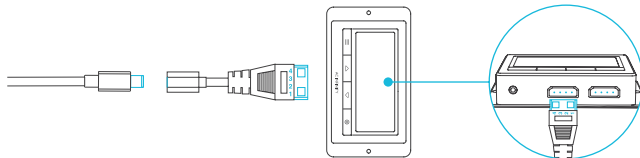

ADDING MORE DEVICES

USING THE DONGLE

Each controller port can support mix-and-matched devices regardless of their size.

When using a 2-port or 4-port dongle, plug your first device into Port 1 for the controller to recognize as the primary device.

All other devices plugged into the dongle will follow programming intended for the device plugged into Port 1.

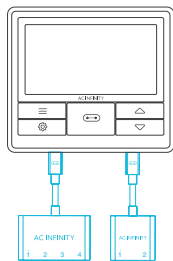

EXTENDING THE CHAIN

When plugging additional dongles into Port 1, all devices plugged into this chain must be of the same type (ex. grow lights of any size) regardless of the length of the dongle chain.

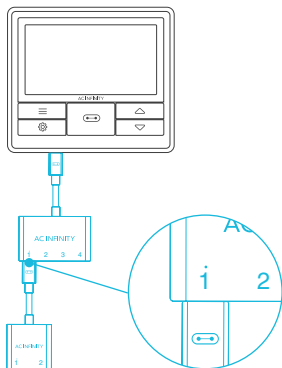

CLEANING

STEP 1

Remove the motor box from the mounting flange to remove any dust or build up. Use a damp cloth to clean the dust and dirt off the impeller and fan blades.

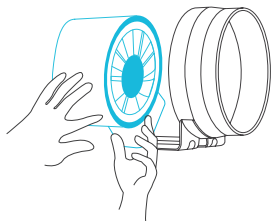

STEP 2

Clean the dust and dirt off the stator blades on the opposite side. Remember to clean the area inside the output and exhaust flanges. Lastly secure the motor box onto the mounting flanges. Secure the motor box with the metal rings.

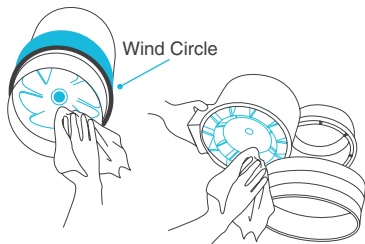

PROGRAMMING

S-SERIES

LIGHT INDICATOR

Features ten LED lights to signify the current level. The LEDs will briefly light up before shutting off. Pressing the button will light up the LEDs.

ON

Pressing the button will turn your device on at level 1. Continue pressing it to cycle through the ten device levels.

OFF

Hold the button to turn your device off. Press it again to return the device level back to the last setting.

Pressing the button after speed 10 will also turn your device off.

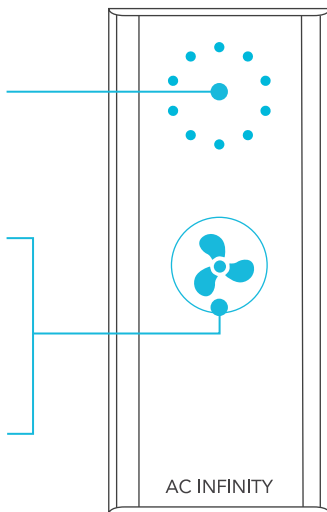

PROGRAMMING

T-SERIES

1. PORT BUTTON

Cycles through up to four connected devices. Each device is programmed independently, or together when navigating to ALL.

4. UP/DOWN BUTTONS

Adjusts the value of your current mode. The up button increases and down button decreases the setting. Hold both to reset values to OFF/Default.

6. PROBE TEMPERATURE

Displays the current temperature that the probe is detecting. Shows "--" if no probe is plugged in. Includes a trend indicator that signals a rise, stability, or fall in temperature within the last hour.

8. PROBE VPD

Displays the current VPD that the probe is detecting (in kPa). Shows "--" if no probe is plugged in. Includes a trend indicator that signals a rise, stability, or fall in VPD within the last hour.

11. CURRENT LEVEL

Displays the connected devices' current setting. Includes a trend indicator that signals if the setting is currently rising, falling, or holding steady.

2. MODE BUTTON

Cycles through the controller's modes: OFF, ON, AUTO (4 triggers), VPD (2 triggers), TIMER TO ON, TIMER TO OFF, CYCLE (ON and OFF), and SCHEDULE (ON and OFF).

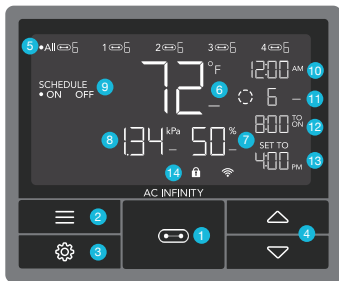

9. CONTROLLER MODE

Displays the controller's current mode. Pressing the mode button cycles through the available modes.

12. COUNTDOWN

Displays the countdown of the TIMER TO ON, TIMER TO OFF, CYCLE, or SCHEDULE mode activates or deactivates the devices. TO ON shows the amount of time left before the devices turn on. TO OFF shows the amount of time left before the device turn off.

3. SETTING BUTTON

Cycles through the controller's settings: DISPLAY, CLOCK, °F / °C, CALIB. T° / H% / kPa, TRANS. T° / H% / kPa, BUFF. T° / H% / kPa, and LEAF OFFSET.

5. PORTS

Displays all connected devices as well as their current level. Digits are displayed by the UIS symbol when a device is plugged into its corresponding port.

7. PROBE HUMIDITY

Displays the current humidity that the probe is measuring. Shows "--" if no probe is plugged in. Includes a trend indicator that signals a rise, stability, or fall in humidity within the last hour.

10. CURRENT TIME

Displays the current time. The internal battery sustains the clock so it does not default to 00:00 if power is cut off.

13. USER SETTING

Displays the value of your current mode. Use the up or down buttons to adjust the value.

14. ALERT ICONS

Displays alerts and statuses of the controller, including the controller lock, CLIMATE alert, and TIMER alert.

PROGRAMMING

T-SERIES

PORTS

Pressing the port button will cycle through the controller's available ports: ALL, 1, 2, 3, and 4. Dot indicates the current device. No digit is displayed if a device is not plugged into the corresponding port.

ALL PORTS

Navigate to the ALL port to set simultaneous programming for all connected devices.

Programming set in this port mode applies to all connected devices, but will not be active if you navigate to other ports. Re-entering the ALL port will resume its programming.



INDIVIDUAL PORT

Navigate to a numbered port with a connected device to set individual programming.

Programming will run in the background even while you navigate to other numbered ports.



PROGRAMMING

T-SERIES

CONTROLLER MODES

Pressing the mode button will cycle through the controller's available programming modes: OFF, ON, AUTO (4 triggers), VPD (2 triggers), TIMER TO ON, TIMER TO OFF, CYCLE (On and Off), and SCHEDULE (On and Off).

OFF MODE

Your devices will not run while in this mode. The OFF Mode setting also serves as the minimum level the other modes will run at while triggered OFF.

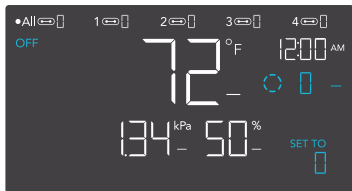

MINIMUM LEVEL

Your devices will run at the level set in OFF Mode, as the minimum level, when triggered to turn OFF. These other modes include the AUTO Mode, CYCLE Mode, TIMER TO ON Mode, TIMER TO OFF Mode, and SCHEDULE Mode.

They will run continuously until triggered ON, at which point they will run at the level set in ON Mode.



*Example shown

If you want your devices to turn off completely when they're triggered to be OFF, set the OFF Mode level to zero.

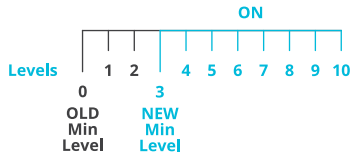

PROGRAMMING

T-SERIES

ON MODE

Your devices will actively run at the level set here, regardless of the probe's reading. The ON Mode setting also serves as the maximum level the other modes will run at.

MAXIMUM LEVEL

Your devices will run at the level set in ON Mode, as the maximum level, when triggered ON, as well as in the AUTO Mode, CYCLE Mode, TIMER TO ON Mode, TIMER TO OFF Mode, and SCHEDULE Mode.

Do not set the ON Mode figure to zero or your device will turn off when it's triggered ON in all modes.

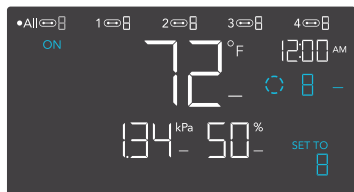

*Example shown



PROGRAMMING

T-SERIES

AUTO MODE (HIGH TEMPERATURE TRIGGER)

Pressing the up or down button sets the high temperature trigger. The devices will activate if the probe's reading meets or exceeds this threshold.

Once triggered, the devices will gradually ramp up to the level set in ON mode. If the probe's reading falls below this trigger point, the devices will gradually slow down to a stop or at the level set in OFF mode.

You may set this trigger below the low temperature trigger to create a specific range in which the devices are active.

This is typically used with devices like air conditioners and cooling fans to help lower the temperature when it gets too hot. For example, if you set a high temperature trigger of 90°F, then your device will activate when the temperature reaches 90°F or higher, and turn off when it falls below 90°F. Products shown here may still be in development.

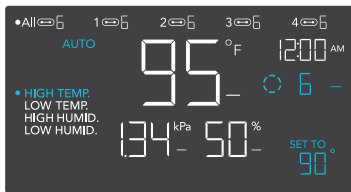

Any of the four trigger points can activate while you are in AUTO Mode, even if you are viewing another trigger point. Set a trigger point to OFF if not in use, by holding down the up and down button. If there is a level set in OFF Mode other than zero the devices will run at that level when triggered to turn off.

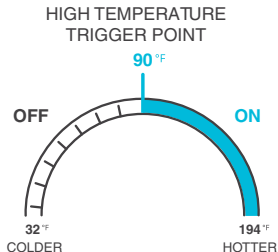
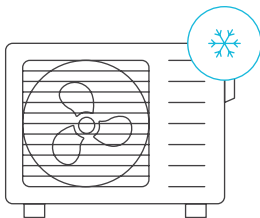

PROGRAMMING

T-SERIES

AUTO MODE (LOW TEMPERATURE TRIGGER)

Pressing the up or down button sets the low temperature trigger. The devices will activate if the probe's reading meets or falls below this threshold.

Once triggered, the devices will gradually ramp up to the level set in ON mode. If the probe's reading rises above this trigger point, the devices will gradually slow down to a stop or at the level set in OFF mode.

You may set this trigger above the high temperature trigger to create a specific range in which the devices are active.

This is typically used with devices like heaters and seedling mats to help raise the temperature when it gets too cold. For example, if you set a low temperature trigger of 40°F, then your device will activate when the temperature falls to 40°F or lower, and turn off when it rises above 40°F. Products shown here may still be in development.

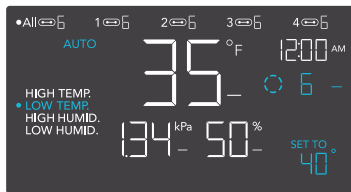

Any of the four trigger points can activate while you are in AUTO Mode, even if you are viewing another trigger point. Set a trigger point to OFF if not in use, by holding down the up and down button. If there is a level set in OFF Mode other than zero the devices will run at that level when triggered to turn off.

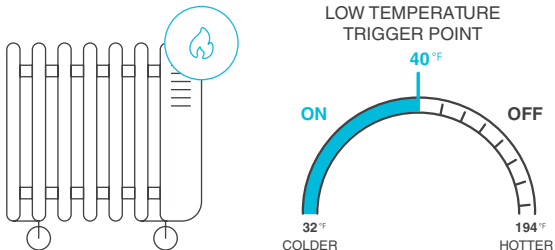

PROGRAMMING

T-SERIES

AUTO MODE (HIGH HUMIDITY TRIGGER)

Pressing the up or down button sets the high humidity trigger. The devices will activate if the probe's reading meets or exceeds this threshold.

Once triggered, the devices will gradually ramp up to the level set in ON mode. If the probe's reading falls below this trigger point, the devices will gradually slow down to a stop or at the level set in OFF mode.

You may set this trigger below the low humidity trigger to create a specific range in which the devices are active.

This is typically used with devices like dehumidifiers to help lower the humidity when it gets too humid. For example, if you set a high humidity trigger of 70%, then your device will activate when the humidity rises to 70% or higher, and turn off when it falls below 70%. Products shown here may still be in development.

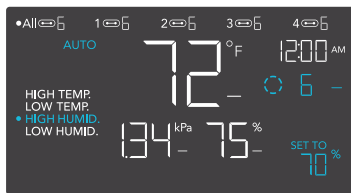

Any of the four trigger points can activate while you are in AUTO Mode, even if you are viewing another trigger point. Set a trigger point to OFF if not in use, by holding down the up and down button. If there is a level set in OFF Mode other than zero the devices will run at that level when triggered to turn off.

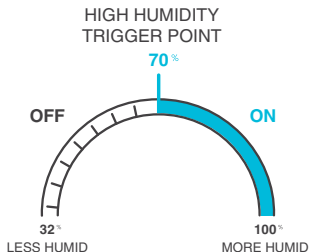
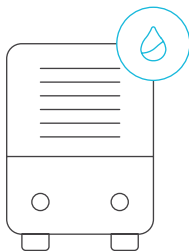

PROGRAMMING

T-SERIES

AUTO MODE (LOW HUMIDITY TRIGGER)

Pressing the up or down button sets the low humidity trigger. The devices will activate if the probe's reading meets or falls below this threshold.

Once triggered, the devices will gradually ramp up to the level set in ON mode. If the probe's reading rises above this trigger point, the devices will gradually slow down to a stop or at the level set in OFF Mode.

You may set this trigger above the high humidity trigger to create a range in which the devices are active.

This is typically used with devices like humidifiers to help raise the humidity when it gets too dry. For example, if you set a low humidity trigger of 50%, then your device will activate when the humidity falls to 50% or lower, and turn off when it rises above 50%. Products shown here may still be in development.

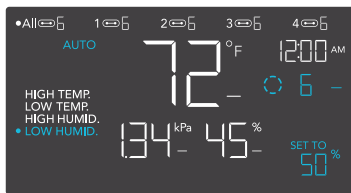

Any of the four trigger points can activate while you are in AUTO Mode, even if you are viewing another trigger point. Set a trigger point to OFF if not in use, by holding down the up and down button. If there is a level set in OFF Mode other than zero the devices will run at that level when triggered to turn off.

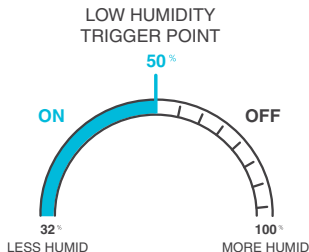
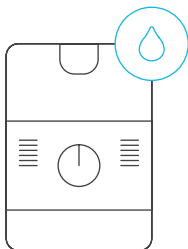

PROGRAMMING

T-SERIES

VPD MODE (HIGH VPD TRIGGER)

Pressing the up or down button sets the high VPD trigger. The devices will activate if the probe's reading meets or exceeds this threshold.

Once triggered, the devices will gradually ramp up to the level set in ON mode. If the probe's reading falls below this trigger point, the devices will gradually slow down to a stop or at the level set in OFF mode.

You may set this trigger below the low VPD trigger to create a specific range in which the devices are active.



Either of the two trigger points can activate while you are in VPD Mode, even if you are viewing another trigger point. Set a trigger point to OFF if not in use, by holding down the up and down button. If there is a level set in OFF Mode other than zero the devices will run at that level when triggered to turn off.

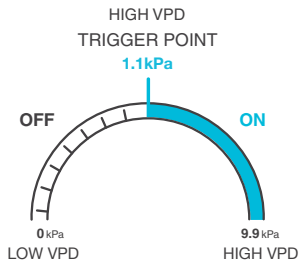

PROGRAMMING

T-SERIES

VPD MODE (LOW VPD TRIGGER)

Pressing the up or down button sets the low VPD trigger. The devices will activate if the probe's reading meets or falls below this threshold.

Once triggered, the devices will gradually ramp up to the level set in ON mode. If the probe's reading falls below this trigger point, the devices will gradually slow down to a stop or at the level set in OFF mode.

You may set this trigger below the low VPD trigger to create a specific range in which the devices are active.



Either of the two trigger points can activate while you are in VPD Mode, even if you are viewing another trigger point. Set a trigger point to OFF if not in use, by holding down the up and down button. If there is a level set in OFF Mode other than zero the devices will run at that level when triggered to turn off.

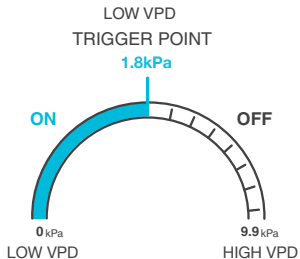

PROGRAMMING

T-SERIES

TIMER TO ON MODE

Pressing the up or down button sets a countdown time. During the countdown, your device will be set to OFF. Once the timer ends, your device will trigger to turn on. If there is a level set in OFF Mode, the devices will run at that level during the countdown and when triggered to turn off.

The countdown will begin if no buttons are pressed for 5 seconds. The time left on the countdown is shown on the lower right corner of the display above the setting. Leaving the timer mode while the countdown is running will pause it until you return to this mode.



TIMER TO ON
(COUNTDOWN END POINT)

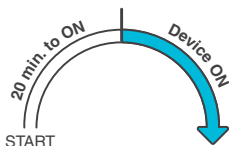

TIMER TO OFF MODE

Pressing the up or down button sets a countdown time. During the countdown, your device will be set to ON. Once the timer ends, your device will trigger to turn off. If there is a level set in OFF Mode, the devices will run at that level after the end of the countdown.

The countdown will begin if no buttons are pressed for 5 seconds. The time left on the countdown is shown on the lower right corner of the display above the setting. Leaving the timer mode while the countdown is running will pause it until you return to this mode.



TIMER TO OFF
(COUNTDOWN END POINT)

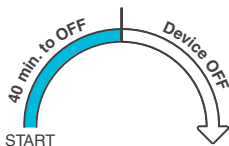

PROGRAMMING

T-SERIES

CYCLE MODE (ON AND OFF)

Set an on duration and an off duration for the devices to cycle through continuously. Press the up or down button to first set a duration for the devices to activate. Then press the mode button again and set a duration for the devices to deactivate.

When the devices are activated, they will run at the level set in ON Mode. When the devices are deactivated, they will run at the level set in OFF Mode.

The countdown will begin if no buttons are pressed for 5 seconds. The time left on the countdown before the next ON or OFF phase is displayed below the current level. Leaving the cycle mode while the countdown is running will pause it until you return to this mode.

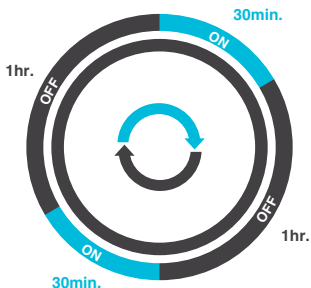

If there is a level set in OFF Mode other than zero, the devices will run at that level when triggered to turn off.

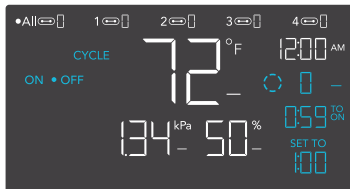
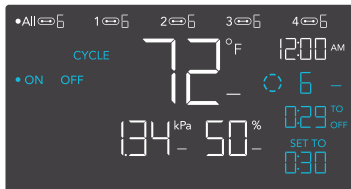

PROGRAMMING

T-SERIES

SCHEDULE MODE (ON AND OFF)

Sets an on clock-time and an off clock-time schedule for the devices to follow daily. Press the up or down button to first set up an on clock-time to trigger ON mode, then press the mode button to set an off clock-time to trigger OFF mode. Please be sure to set the current clock time under settings.

When the devices are triggered to activate, they will run at the level set in ON Mode. When the devices are triggered to deactivate, they will run at the level set in OFF Mode.

The countdown will begin if no buttons are pressed for 5 seconds. The time left on the countdown before the next on or off phase is displayed below the current level. The devices will not follow this schedule if you leave this mode. If you re-enter the Schedule Mode, they will continue to follow the latest schedule you have set.



If there is a level set in OFF Mode other than zero, the devices will run at that level when triggered to turn off.

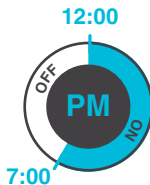
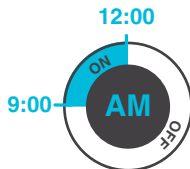

PROGRAMMING

T-SERIES

CONTROLLER SETTINGS

Pressing the setting button will cycle through the controller's available settings: DISPLAY, CLOCK, °F / °C, CALIB. T° / H% / kPa, TRANS. T° / H% / kPa, BUFF. T° / H% / kPa, and LEAF OFFSET.

DISPLAY SETTING

Adjusts the display brightness and auto-dimming. Press the up or down button to cycle through levels 1, 2, 3, A2 and A3; 3 being the highest brightness setting, while 1 is the lowest. In settings 1, 2 and 3, the display will stay at that brightness level and will not automatically dim the display.

A2 and A3 will set the brightness level at 2 and 3, respectively, and will dim down the brightness level 1 when the controller is not being used after 15 seconds.

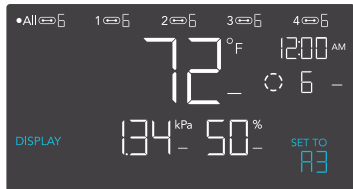

TOGGLING THE DISPLAY

Lock the controller by holding the setting button.

Press the setting button to turn the display off. Pressing the setting button again will turn the display back on.

Programs will still run in the background while the LCD screen is off.



PROGRAMMING

T-SERIES

°F/°C SETTING

Changes the displayed units to Fahrenheit or Celsius. Press the up or down button to cycle through F and C. All displayed units will automatically convert when adjusting this setting.

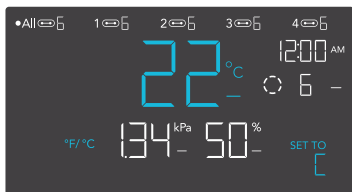

CLOCK SETTING

Adjusts the current clock time. Press the up or down button to increase or decrease the time. Once you cycle through 12:00 each time, the units will automatically change to AM or PM. The clock time is located at the top right corner of the display.



PROGRAMMING

T-SERIES

CALIBRATION TEMPERATURE SETTING

Adjusts the temperature reading the sensor probe is measuring. Press the up or down button to increase or decrease the data figure in 1° increments. The calibration cycle ranges from -20°F to 20°F (or -10°C to 10°C) and will be applied to the sensor probe's measurements.

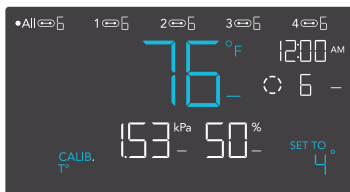

CALIBRATION HUMIDITY SETTING

Adjusts the relative humidity reading the sensor probe is measuring. Press the up or down button to increase or decrease the data figure in 1% increments. The calibration cycle ranges from -10% to 10% and will be applied to the sensor probe's measurements.

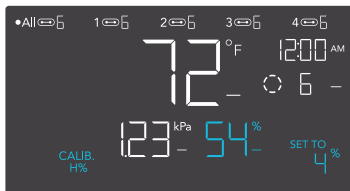

CALIBRATION LEAF OFFSET SETTING

Adjusts the VPD reading the sensor probe is measuring. Press the up or down button to increase or decrease the data figure in 1° increments. The calibration cycle ranges from -20°F to 20°F (or -10°C to 10°C) and will be applied to the sensor probe's measurements.

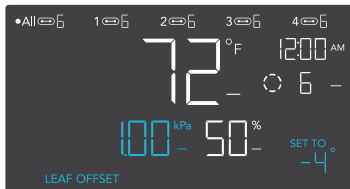

PROGRAMMING

T-SERIES

TRANSITION TEMPERATURE SETTING

Adjusts how gradually your device will shift between levels when triggered ON by the AUTO Mode's temperature trigger. This will determine how much the probe temperature needs to increase to step up to the next level setting.

The higher the transition setting is, the wider the temperature gap is between levels. The lower the transition setting is, the smaller the temperature gap is between levels. If this figure is set to zero, your device will jump to your maximum level when triggered ON.

Press the up or down button to set a transition threshold between 0°F and 20°F (0°C and 10°C). When the sensor temperature first reaches or crosses the temperature trigger point, the level will increase by one (exiting OFF Mode). Each time the threshold level is crossed, the level will ramp up by one until it reaches the level set in ON Mode.

EXAMPLE

In this example, your high temperature trigger is set at 80°F, the OFF Mode level is 0, and the ON Mode level is 6. If the transition threshold is set to 0°F, then once the sensor temperature reaches or exceeds 80°F, the devices will trigger to run at level 6. However, if the transition threshold is set to 2°F, then the devices will trigger to run at level 1 when the temperature reaches or exceeds 80°F. It will then ramp up to level 2 when the temperature reaches or exceeds 82°F, level 3 at 84°F, etc. From 90°F on, it will run at level 6, the level set in ON Mode.

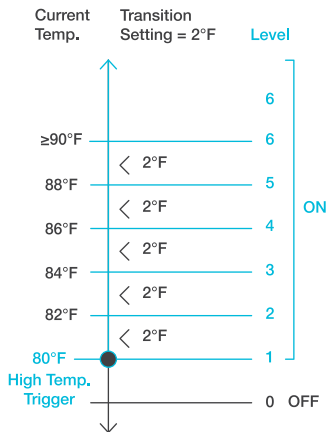
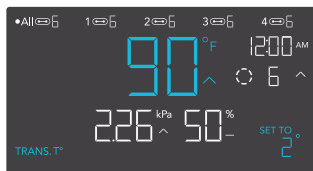

PROGRAMMING

T-SERIES

TRANSITION HUMIDITY SETTING

Adjusts how gradually your device will shift between levels when triggered ON by the AUTO Mode's humidity trigger. This will determine how much the probe humidity needs to increase to step up to the next level setting.

The higher the transition setting is, the wider the humidity gap is between levels. The lower the transition setting is, the smaller the humidity gap is between levels. If this figure is set to zero, your device will jump to your maximum level when triggered ON.

Press the up or down button to set a transition threshold between 0% and 10%. When the sensor humidity first reaches or crosses the humidity trigger point, the level will increase by one (exiting OFF Mode). Each time the threshold level is crossed, the level will ramp up by one until it reaches the level set in ON Mode.

EXAMPLE

In this example, your high humidity trigger is set at 70%, the OFF Mode level is 0, and the ON Mode level is 6. If the transition threshold is set to 0%, once the sensor humidity reaches or exceeds 70% then the devices will trigger to run at level 7. However, if the transition threshold is set to 2%, then the devices will trigger to run at level 1 when it reaches or exceeds 70%. It will then step up to level 2 when reaching or exceeding 72%, level 3 at 74%, etc. From 80% on, it will run at level 6, the level set in ON Mode.

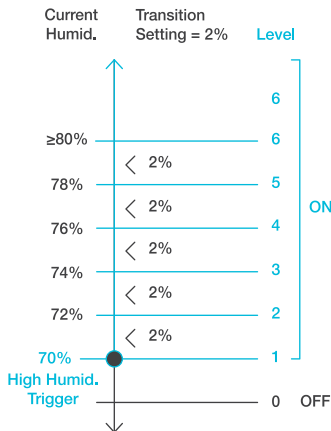

PROGRAMMING

T-SERIES

TRANSITION VPD SETTING

Adjusts how gradually your device will shift between levels when triggered ON by the VPD trigger. This will determine how much the probe VPD needs to increase to step up to the next level setting.

The higher the transition setting is, the wider the VPD gap is between levels. The lower the transition setting is, the smaller the VPD gap is between levels. If this figure is set to zero, your device will jump to your maximum level when triggered ON.

Press the up or down button to set a transition threshold between 0.1 kPa and 1.0 kPa. When the sensor VPD first reaches or crosses the VPD trigger point, the level will increase by one (exiting OFF Mode). Each time the threshold level is crossed, the level will ramp up by one until it reaches the level set in ON Mode.

EXAMPLE

In this example, your high VPD trigger is set at 0.1 kPa, the OFF Mode level is 0, and the ON Mode level is 6. If the transition threshold is set to 0 kPa, then once the sensor temperature reaches or exceeds 0.1 kPa, the devices will trigger to run at level 6. However, if the transition threshold is set to 0.2 kPa, then the devices will trigger to run at level 1 when the VPD reaches or exceeds 0.1 kPa. It will then ramp up to level 2 when the VPD reaches or crosses 0.3 kPa, level 3 at 0.5 kPa, etc. From 1.1 kPa on, it will run at level 6, the level set in ON Mode.

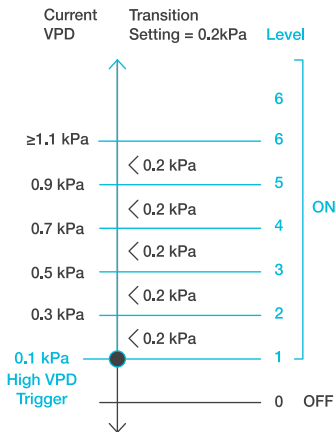

PROGRAMMING

T-SERIES

BUFFER TEMPERATURE SETTING

The buffer figure will create a trigger-off point below your set trigger point to prevent your device from shutting off too quickly. Press the up or down button to cycle through buffer range from 0°F to 8°F (or 0°C to 4°C).

In high temperature triggers, your device will turn on, only turning off when the temperature falls below your buffer setting.

In low temperature triggers, your device will turn on, only turning off when the temperature rises above your set buffer setting.

EXAMPLE

In this example, your High Temperature Trigger is set at 89°F and your Temperature Buffer is set at 6°F. Your device will trigger on when it meets or rises above 89°F, and only trigger off when it falls below 83°F. The 83°F figure is obtained by taking your High Temperature Trigger of 89°F and subtracting your Temperature Buffer of 6°F.

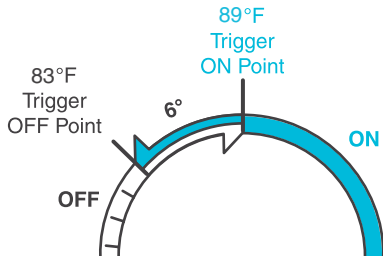
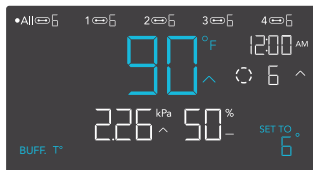

PROGRAMMING

T-SERIES

BUFFER HUMIDITY SETTING

The buffer figure will create a trigger-off point below your set trigger point to prevent your device from shutting off too quickly. Press the up or down button to cycle through buffer range from 0% to 10%.

In high humidity triggers, your device will turn on, only turning off when the humidity falls below your buffer setting.

In low humidity triggers, your device will turn on, only turning off when the humidity rises above your set buffer setting.

EXAMPLE

In this example, your High Humidity Trigger is set at 49% and your Humidity Buffer is set at 4%. Your device will trigger on when it meets or rises above 49%, and only trigger off when it falls below 45%. The 45% figure is obtained by taking your High Humidity Trigger of 49% and subtracting your Humidity Buffer of 4%.

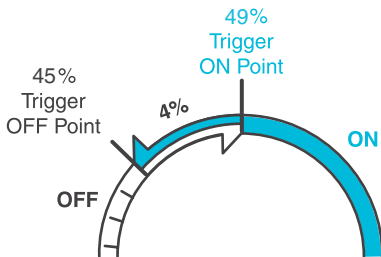

PROGRAMMING

T-SERIES

BUFFER VPD SETTING

The buffer figure will create a trigger-off point below your set trigger point to prevent your device from shutting off too quickly. Press the up or down button to cycle through buffer range from 0.1 kPa and 1.0 kPa.

In high VPD triggers, your device will turn on, only turning off when the VPD falls below your buffer setting.

In low VPD triggers, your device will turn on, only turning off when the VPD rises above your set buffer setting.

EXAMPLE

In this example, your High VPD Trigger is set at 2.51 kPa and your VPD Buffer is set at 0.2 kPa. Your device will trigger on when it meets or rises above 2.51 kPa, and only trigger off when it falls below 2.31 kPa%. The 2.51 kPa figure is obtained by taking your High VPD Trigger of 2.51% and subtracting your VPD Buffer of 0.2 kPa.

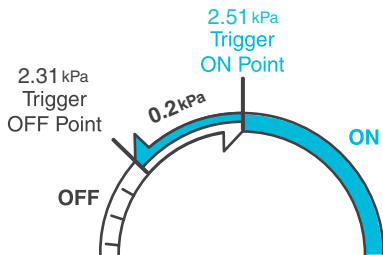
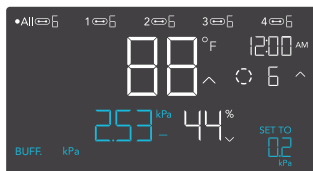

PROGRAMMING

T-SERIES

ALERT ICONS

The alert icons are displayed at the top of the screen. Icons may flash when the controller signals an alert to notify you of any triggered function or alarm.

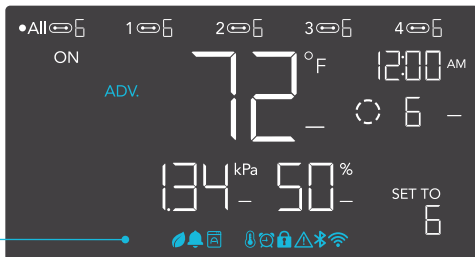

ADVANCE PROGRAMMING

Displays when an advance program set in the app is active. "ADV." will appear and override the controller if an automation program is in use.



AUTO MODE ALERT

Flashes whenever any of the auto mode triggers (high temperature, low temperature, high humidity, or low humidity) activate your devices.



TIMER ALERT

Flashes when a countdown has completed for TIMER TO ON, TIMER TO OFF, CYCLE, or SCHEDULE Mode.



VPD ALERT

Flashes whenever either VPD mode triggers (high VPD or low VPD) activate your devices.

PROGRAMMING

T-SERIES

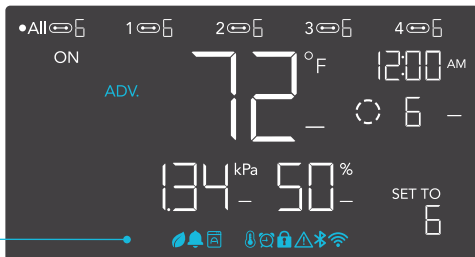

WI-FI

Appears when the physical controller is connected to the app via Wi-Fi.



DISPLAY LOCK ALERT

Displays when you lock the controller. The icon will flash and beep if you attempt to adjust the controller while it is still locked.



ALERT

Flashes and beeps with an alert whenever a plugged-in device experiences interference to its functioning. Check your devices for possible issues.



ALARM

Flashes and beeps with an alert if the temperature/humidity/VPD meet the trigger point set in the app.

OTHER SETTINGS

FACTORY RESET

Holding the mode, up, and down buttons together for 5 seconds will reset your controller and restore factory settings. This clears all user parameters in each controller mode and setting.

HOLD +   

CONTROLLER LOCK

Holding the setting button will lock the controller in your current mode. While your controller is locked, no parameters may be adjusted, nor will you be able to switch modes. Holding the setting button again will unlock the controller.

HOLD + 

HIDE SCREEN

Lock the controller so no settings can be adjusted. See above. Then press the setting button to turn the display off. Pressing it again will turn the display back on. Programs will still run in the background while the LCD screen is off.

PRESS + 

JUMP TO OFF MODE

Holding the mode button for 3 seconds while in any mode or setting will automatically jump to OFF Mode. This function is disabled if the controller is locked.

HOLD + 

RESET TO OFF/DEFAULT

Holding the up and down buttons together for 2 seconds will reset the value of your current mode or controller setting to OFF/Default. Pressing either the up or down button will return to the previous value.

HOLD +  

AUTO INCREASING OR DECREASING

Holding the up or down button will increase or decrease the user setting automatically until you release them.

HOLD + 

HOLD + 

DOWNLOAD THE APP

THE AC INFINITY APP

The AC Infinity app enables you to connect with the next generation of our intelligent controllers, giving you access to advance programs and environmental data*.

1

Download the AC Infinity app from the App Store or Play Store by searching “AC Infinity”.



2

Open the AC Infinity app and follow the instructions on page 60-66 to pair your controller with the app.



HOW TO USE THE APP

Visit our website at www.acinfinity.com or open your smartphone camera and scan the QR code below for more information on the AC Infinity app.



*Appearance and features subject to change.

ADD A DEVICE

BLUETOOTH

SETUP AND PAIRING

Power your device on before pairing your controller with the app. Logging in or creating an account beforehand will expedite the pairing process. Have your Wi-Fi network's name and password ready.

1

Tap on the "+" tab to add your smart device.

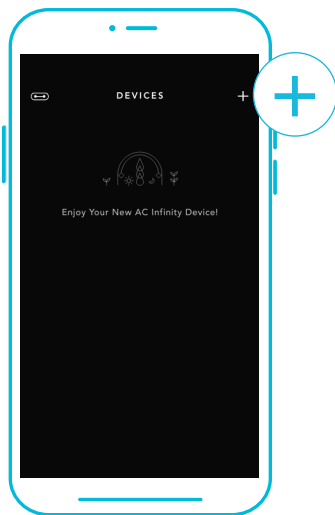

2

Select "Smart Controllers".

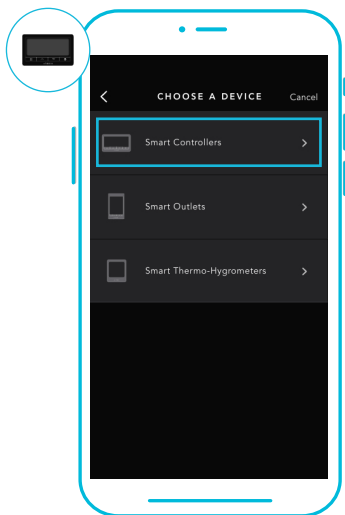

Wi-Fi and location permissions must be enabled on your mobile device before starting the pairing process.

ADD A DEVICE

BLUETOOTH

3

Select CONTROLLER 69 PRO.

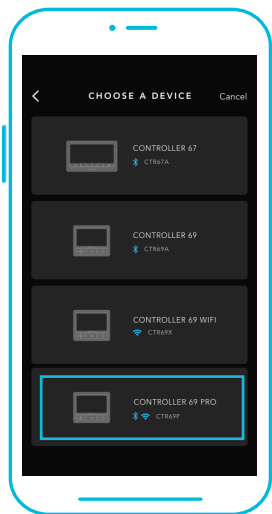

4

Hold the port button for 5 seconds to activate Bluetooth. Wait for the Bluetooth icon to start flashing on your controller's screen to release the button.



ADD A DEVICE

BLUETOOTH

5

Connect using Bluetooth. To connect using Wi-Fi, skip to step 8.

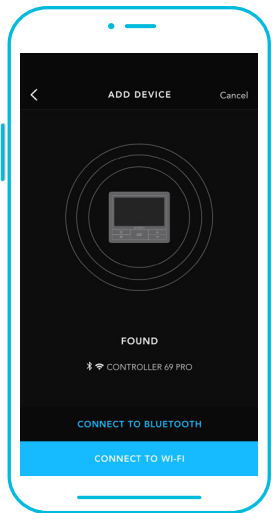

6

Connecting with Bluetooth will disable Wi-Fi functionality. Go to the app settings page to re-enable and connect using Wi-Fi.

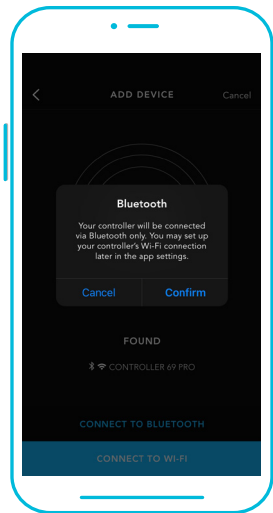

When pairing the app around multiple controllers, move your mobile device closer to your desired controller.

ADD A DEVICE

BLUETOOTH

7

Tap the DONE button to complete the pairing process.

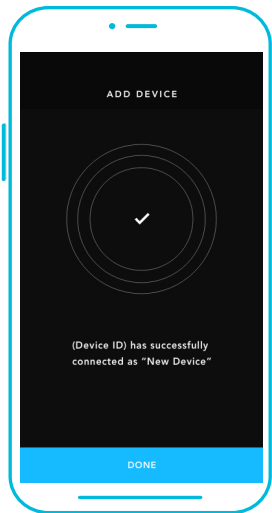

ADD A DEVICE

WI-FI

8

Repeat steps 1-5. Log in or create an account to continue.

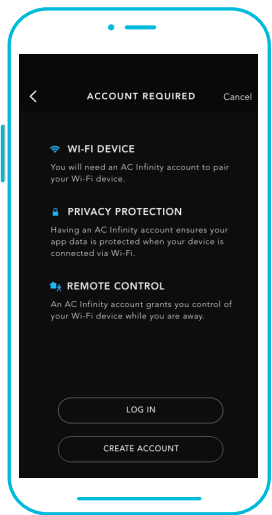

9

Enter your Wi-Fi network's password. You may also connect to an alternate 2.4 GHz router*.

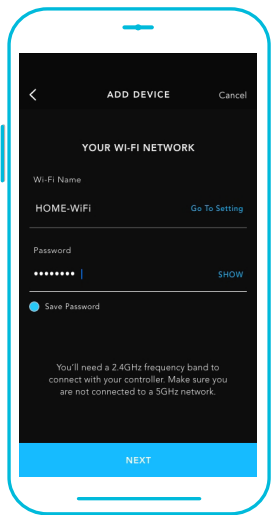

When pairing the app around multiple controllers, move your mobile device closer to your desired controller.

ADD A DEVICE

WI-FI

10

Follow these tips if the pairing process is unsuccessful.



11

Tap the DONE button to complete the pairing process.

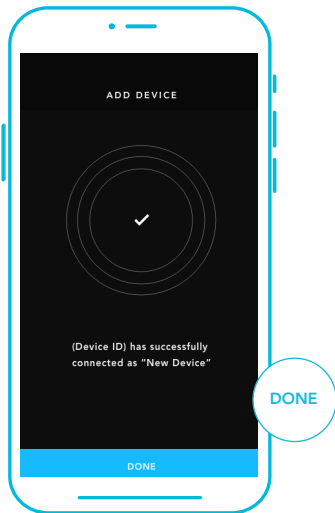

*This controller is only compatible with 2.4 GHz frequency band routers. When connecting using Wi-Fi, make sure your mobile device is not connected to a 5 GHz frequency band network.

ADD A DEVICE

WI-FI

12

Your controller will appear in your smart device with a unique ID.

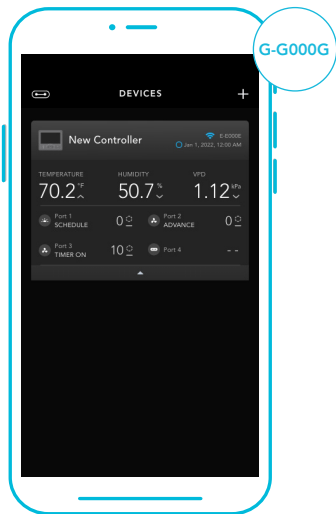

CONTROLLER 69 PRO FAQ

Q: What devices are compatible with the CONTROLLER 69 PRO?

A: All AC Infinity devices that contain a UIS connector are compatible. If your AC Infinity device has a 4-pin Molex connector and an EC motor, it may still be compatible with the use of a UIS adapter to convert its connector to fit with the controller.

Q: What does “level” refer to in the controller and app?

A: The level represents the intensity the device is running at. This is represented by a digit 0 to 10. Zero means the device is off, and 10 represents its running at its maximum. For fan devices, the level would be referring to their speed. For light devices, the level would be referring to its brightness. Note that on and off devices do not have a level setting.

Q: Why is my device is not turning off when the programming is triggering it to be off?

A: The figure set in OFF Mode determines the device’s level when it’s triggered to be OFF in all other modes. Set this figure to zero if you want the device to turn off when triggered OFF.

If this is occurring in AUTO Mode, check the points of your high and low triggers, which can all activate concurrently. Turn off any triggers that are not in use. If you are using the app, check to see if any ADVANCE programming is active, which can override any control programming.

Q: Why does my device not run or run at low levels when the programming is triggering it to be on?

A: The figure set in ON Mode determines the device’s level when it’s triggered to be ON in all other modes. Make sure this figure is not set to zero or the device will not run when triggered to be ON.

If this is occurring in AUTO Mode, check the points of your high and low triggers, which can all activate concurrently. Turn off any triggers that are not in use. If you are using the app, check to see if any ADVANCE programming is active, which can override any control programming.

CONTROLLER 69 PRO FAQ

Q: How do I stop my device from turning on and off too quickly in AUTO Mode?

A: The figure set in the TRANSITION under SETTINGS will determine how the device ramps up in levels when triggered to run in AUTO Mode. Set a transition threshold X. For every multiple of X that has surpassed your trigger point, the device will increase by one level. The lower the transition threshold is set to, the easier it will be for the device to ramp up in levels. If set to zero, the device will jump to the max set speed without ramping when triggered. This may cause the device to turn on and off quickly if the climate fluctuates back and forth. Increase the transition threshold number to help smooth out the transitions. Check the points of your high and low triggers, which can all activate concurrently. Turn off any triggers that are not in use.

Q: How do I set a minimum speed for constant ventilation, that would ramp up when triggered?

A: If a fan device is connected, the figure set in OFF Mode determines the fan speed when it's triggered to be OFF in all other modes. When the fan isn't triggered ON, it will be considered OFF and so it will run at that minimum speed continuously. Once triggered ON, it will change its speed to the figure set under ON Mode.

Q: Where is the best place to position the sensor probe?

A: Place the sensor probe as close as possible to the hottest or most humid spot in your space.

Q: Do I need to remove the plastic cap from the probe?

A: Yes. You will need to remove the plastic cap so the probe can accurately read climate conditions.

Q: Can I connect different-sized fans to the same controller?

A: Please refer to pages 30-31 for details on adding more fan units.

CONTROLLER 69 PRO FAQ

Q: Will I be able to use this controller with my own devices?

A: The CONTROLLER 69 PRO is only compatible with devices in the UIS ecosystem. Look for our logo on your AC Infinity device's packaging for UIS compatibility.

Q: Does the controller retain its settings after power is shut off?

A: Yes. If the controller's power is cut off and is powered on afterward, your settings will remain.

Q: My controller isn't pairing with the app. How do I fix this?

A: If the pairing process isn't successful, press any button to return to the normal screen. Then hold the port button for 5 seconds to try again. When starting the pairing process around multiple Wi-Fi controllers, move your smart device closer to the controller you wish to connect the app with.

Q: Why does the app ask me for location permissions?

A: The app requires location permissions to find the relative position of your smart controller and communicate with existing Bluetooth devices already paired with the app. All Android devices prior to system version 12.0 will require location permissions to be turned on for the Bluetooth scan to be successful.

Q: Why do the port's level digits on the screen occasionally flash when I unplug a device?

A: The controller may have received electronic interference during the disconnection. To fix this, completely cut off power from the controller by unplugging all connected devices. Then plug them back into their previous ports and resume normal use.

AC INFINITY PRODUCTS

Advance Grow Tents

The CLOUDLAB series is a line of grow tents designed to create ideal growing conditions and facilitate indoor plant cultivation year-round. Features 2000D thick oxford canvas lined with inner diamond patterned mylar that maximizes grow light luminosity, and a reinforced frame with 150 lb. weight capacity. Includes a mounting plate to install your AC Infinity controller onto.

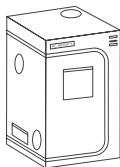

Inline Duct Fans

The CLOUDLINE series is a line of duct fans designed to quietly ventilate AV rooms and closets, as well as various DIY air circulation and exhaust projects. Features a thermal controller with intelligent programming that will automatically adjust duct fan speeds in response to changing temperatures.



Carbon Filters

The duct carbon filter is designed to eliminate odors and chemicals for grow tents and hydroponic spaces. It utilizes premium grade Australian charcoal that features greater absorption power and a longer lifespan. Enables maximum airflow pass through as part of an intake or an exhaust system.

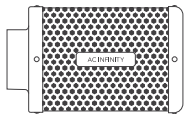

Discover the latest innovations in environmental controls at acinfinity.com

WARRANTY

This warranty program is our commitment to you, the product sold by AC Infinity will be free from defects in manufacturing for a period of two years from the date of purchase. If a product is found to have a defect in material or workmanship, we will take the appropriate actions defined in this warranty to resolve any issues.

The warranty program applies to any order, purchase, receipt, or use of any products sold by AC Infinity or our authorized dealerships. The program covers products that have become defective, malfunctioned, or expressively if the product becomes unusable. The warranty program goes into effect on the date of purchase. The program will expire two years from the date of purchase. If your product becomes defective during that period, AC Infinity will replace your product with a new one or issue you a full refund.

The warranty program does not cover abuse or misuse. This includes physical damage, submersion of the product in water, incorrect installation such as wrong voltage input, and misuse for any reason other than intended purposes. AC Infinity is not responsible for consequential loss or incidental damages of any nature caused by the product. We will not warrant damage from normal wear such as scratches and dings.

Contact our dealers department at dealers@acinfinity.com or (626) 838-4656 for more information about our dealers and distributors program. Contact our customer service department at support@acinfinity.com or 626-923-6399 for product and warranty assistance. Our business hours are Monday through Friday, 9:00 am to 5:00 pm PST.



If you have any issues with this product, contact us and we'll happily resolve your problem or issue a full refund!

COPYRIGHT © 2022 AC INFINITY INC. ALL RIGHTS RESERVED

No part of the materials including graphics or logos available in this booklet may be copied, photocopied, reproduced, translated or reduced to any electronic medium or machine readable form, in whole or in part, without specific permission from AC Infinity Inc.

www.acinfinity.com